

An elegant and efficient lantern with translucent diffuser provide a unique, comfortable light choice with glare free light distribution. Aesthetically designed sturdy construction ensures a long life against all weather condition, maintaining initial performances through the lifetime of the installation.

Product Description

- Aluminium housing, integrated with MS hotdip pipe along with die cast aluminium base through supporting arms made of mild steel.
- Diffuser placed into the provision formed on the periphery of the bottom cover.
- Non yellowing UV stabilized translucent acrylic diffuser.
- Low power loss LED driver with 36W LED.
- Suitable for mounting on 50mm OD pipe.
- Cable entries for through-wiring of mains supply cable.
- Integral constant current power supply
- CRI (Ra) : ≥ 80
- Prewired with LED driver and suitable for operating on 240V, 50Hz single phase ac supply.
- Ordering guide : KL-5380-CCT (Colour Temperature)
- Available CCT : 3000K, 4000K, 5700K

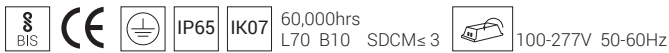

Product Benefits

- High luminous efficiency at reduced wattage.
- Elegance, Functionality.
- Environmental friendly, moisture proof, insect free.
- Dark sky compliant protects pedestrians from glare, in addition to preventing spill light above the horizontal plane.
- Sustainable LED technology offers durability and optimal light output with low power consumption.

Area of Application

Illuminating parks, Gardens, commercial complex, Pathways in residential buildings & office complex.

Available Finish

Pure polyester powder coated

- Graphite grey
- Anthracite grey
- Jet black





Technical Specifications

General

ID	: 5380
System Wattage	: 36W LED
Driver Integral	: Constant Current
Input Voltage	: 230-240Vac
Frequency	: 50-60 Hz
Operating Voltage	: 100-277Vac
Operating Temperature	: -15°C~+50°C

Physical

Body	: Extruded aluminium with Spun Aluminium Top
Diffuser	: Translucent Acrylic
Mounting	: Suitable for Mounting on Ø50mm OD Pipe
Finish	: Graphite Grey / Jet Black Anthracite Grey

Light Source

Light Source	: NICHIA
LED Lumens	: 5400 lm
CRI (Ra)	: >80
LED Colour Temperature	: 3000K / 4000K / 5700K





Driver

Power Supply	: Integral
Power Factor	: >0.95
THD	: <10%
Surge Protection	: 4KV
Efficiency	: >85%

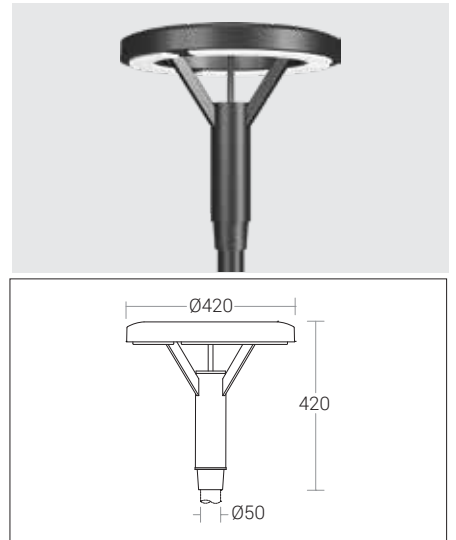
Optical Performance

Colour Temperature	: 3000K / 4000K / 5700K
Luminous flux	: 2550 / 2713 / 2776 lm
Light Distribution	: 120°





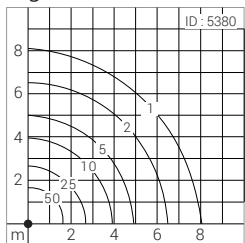

 60,000hrs L70 B10 SDCM≤3  100-277V 50-60Hz

Light Distribution



Applied Photometry : H=3m