

LED compact spot light luminaires designed to provide directional light. The luminaires comes with a connecting cable and an earth spike for portable installation or bracket for permanent installation on a wall, under a ceiling or on a column.

### Product Description

- Luminaire made of pressure die cast aluminium alloy of high corrosion resistance and non corrosive stainless steel fasteners.
- Clear toughened glass.
- Mounting earth spike or die-cast bracket arrangement to facilitate easy installation at any desired location.
- Swivel range of 0°-90°.
- Luminaire supplied with 0.5 metre cable length and a IP67 connector.
- Silicone gasket.
- Cable entries for through-wiring of mains supply cable.
- Integral constant current power supply
- CRI (Ra) : ≥80 (90 CRI - On Request)
- Prewired with LED driver and suitable for operating on 240V, 50Hz single phase ac supply.
- Ordering guide : KL-7052-CCT (Colour Temperature)
- Available CCT : 3000K, 4000K (CW on request)



### Product Benefits

- Sturdy construction in order to maintain performance of the luminaire and to reduce maintenance costs.
- Quick & simple installation.
- Clear glass in the front with continuous rubber gasket to ensure adequate sealing against ingress of moisture, dust, insects etc.,
- Sustainable LED technology offers durability and optimal light output with low power consumption.

### Areas of Application

Pathways, Parks, Sculptures, Gardens, Structures and Landscape lighting.

### Available Finish

Pure polyester powder coated

- Graphite grey
- Anthracite grey
- Jet black



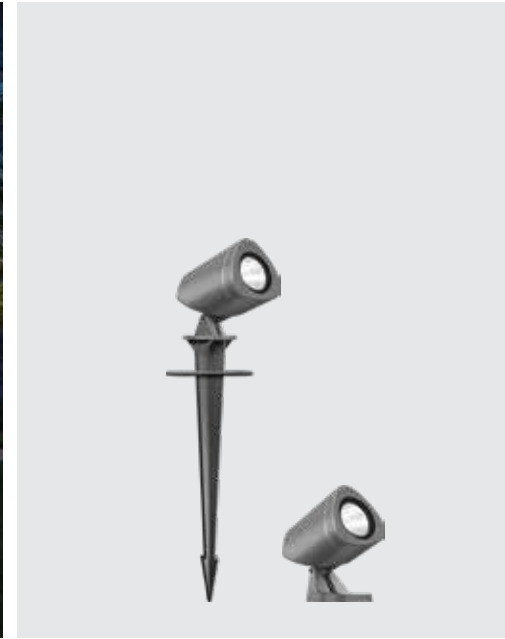

**Technical Specifications**

**General**

ID	: 7052 / 7057
System Wattage	: 6W LED
Driver Integral	: Constant Current
Input Voltage	: 230-240Vac
Frequency	: 50-60 Hz
Operating Voltage	: 100-240Vac
Operating Temperature	: -15°C~+50°C

**Light Source**

Light Source	: LUMILED / OSRAM
LED Lumens	: 900 lm
CRI (Ra)	: ≥80
LED Colour Temperature	: 3000K / 4000K

**Driver**

Power Supply	: Integral
Power Factor	: ≥0.60
Surge Protection	: 2KV
Efficiency	: >70%

**Physical**

Body	: Die-cast Aluminium Alloy
Diffuser	: Clear Toughened Glass
Mounting	: Spike / Die-cast Aluminium Bracket
Finish	: Powder Coated Graphite Grey / Jet Black Anthracite Grey

**Optical Performance**

Colour Temperature	: 3000K / 4000K
Luminous flux	: 443 lm / 494 lm for 25°
Beam Angle	: 15° / 25° / 40°

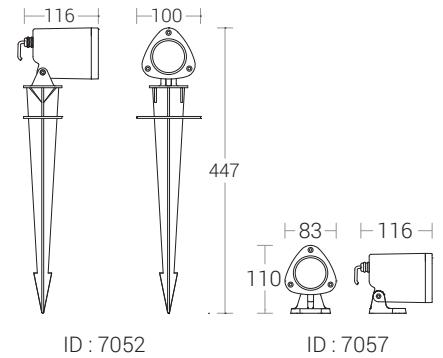

**Photometric Data**

